



# SUPPLEMENTARY REGULATIONS

from 26th to 28th of October



AUTOMÓVEL  
CLUB DE PORTUGAL

Rua General Humberto Delgado, 3  
2685 - 340 PRIOR VELHO  
Tel: 351 219 429 187 Fax: 351 219 429 192  
acpmotorsport@acp.pt



## INDEX

	Past Winners	3
<b>Article 1</b>	Introduction	6
<b>Article 2</b>	Organization	6
<b>Article 3</b>	Programme	9
<b>Article 4</b>	Regulations	10
<b>Article 5</b>	Categories	11
<b>Article 6</b>	Licences	11
<b>Article 7</b>	Entries	11
<b>Article 8</b>	Insurance	13
<b>Article 9</b>	Identification	13
<b>Article 10</b>	Advertising	14
<b>Article 11</b>	Training and Reconnaissance	14
<b>Article 12</b>	Itinerary	14
<b>Article 13</b>	Administrative Checks	15
<b>Article 14</b>	Scrutineering	15
<b>Article 15</b>	Service Areas and Refuelling	16
<b>Article 16</b>	Qualifying Special Stage (QSS1) / Reconnaissance / Fixed Penalties and Maximum Time of SS's	18
<b>Article 17</b>	Briefing	20
<b>Article 18</b>	Starting Order	20
<b>Article 19</b>	Time Controls	20
<b>Article 20</b>	Selective Sections / Route Marking / Passage Control / Interruption of SS / Speed Control / Tyres / Neutralization / Other Procedures	20
<b>Article 21</b>	Safety	25
<b>Article 22</b>	Means of Communication	25
<b>Article 23</b>	Parc Fermé	26
<b>Article 24</b>	Protests / Appeals	26
<b>Article 25</b>	Prize List	26
<b>Article 26</b>	Prize Giving Ceremony	26
<b>Article 27</b>	Environment	26
<b>Appendix I</b>	Advertising Plan	27
<b>Appendix II</b>	Competitors Relation Officer (names and photographs)	28
<b>Appendix III</b>	Equipment	29
<b>Appendix IV</b>	Itinerary	30
<b>Appendix V</b>	Guidelines of Security and Localisation Equipment GPS/GSM and Install and user manual (Stella III and Spica III)	31
<b>Appendix VI</b>	Safety Plan	44
<b>Appendix VII</b>	Service Park Layout	48

## PAST WINNERS

### BIKE

<b>1987</b>	1 <sup>st</sup> Paulo Marques / Marcos Carvalho – Aprila RX 250 2 <sup>nd</sup> António Lopes – Honda CR 250 3 <sup>rd</sup> João Lopes - Honda CR 250	<b>1988</b>	1 <sup>st</sup> António Lopes / João Lopes – Honda CR 250 2 <sup>nd</sup> José Projecto / Bernardo Villar – Yamaha YZ 250 3 <sup>rd</sup> Nuno Carido / Júlio Lopes – Honda CR 250
<b>1989</b>	1 <sup>st</sup> João Lopes – Honda CR 250 2 <sup>nd</sup> Gilles Lalay – Suzuki RMX 3 <sup>rd</sup> António Lopes – Honda CR 500	<b>1990</b>	1 <sup>st</sup> António Lopes – Honda CR 500 2 <sup>nd</sup> João Lopes – Honda CR 500 3 <sup>rd</sup> Thierry Magnaldi – Yamaha YZ 250
<b>1991</b>	1 <sup>st</sup> António Lopes – Honda CR 250 2 <sup>nd</sup> Bernardo Villar – Honda XR 600 3 <sup>rd</sup> David Castera – Yamaha YZ 250	<b>1992</b>	1 <sup>st</sup> António Lopes – Honda CR 250 2 <sup>nd</sup> Thierry Magnaldi – Yamaha YZ 250 3 <sup>rd</sup> Cyril Esquirol – Husqvarna WR 250
<b>1993</b>	1 <sup>st</sup> Carlos Crespo – Kawasaki KX250 2 <sup>nd</sup> Paulo Marques – Honda CR 250 3 <sup>rd</sup> António Lopes – Honda CR 250	<b>1994</b>	1 <sup>st</sup> Paulo Marques – Honda CR 250 2 <sup>nd</sup> Miguel Farrajota – TM Enduro 250 3 <sup>rd</sup> Alain Perez – Kawasaki KX 250
<b>1995</b>	1 <sup>st</sup> Richard Sainct – Honda CR 250 2 <sup>nd</sup> Paulo Marques – Honda CR 250 3 <sup>rd</sup> Mário Brás – KTM LC4 620	<b>1996</b>	1 <sup>st</sup> Alain Perez – Kawasaki KX 250 2 <sup>nd</sup> Paulo Marques – Honda CR 250 3 <sup>rd</sup> António Lopes – Husaberg FE 500
<b>1997</b>	1 <sup>st</sup> Miguel Farrajota – TM 250 2 <sup>nd</sup> Paulo Ascenso – Honda CR 250 3 <sup>rd</sup> Nuno Duarte – Yamaha YR 250	<b>1998</b>	1 <sup>st</sup> Rúben Faria – Yamaha WR 400 2 <sup>nd</sup> Pedro Afonso – Honda 250 3 <sup>rd</sup> Luís Serra – Yamaha YZ 250
<b>1999</b>	1 <sup>st</sup> Rúben Faria – Yamaha YZ 400F 2 <sup>nd</sup> Pedro Afonso – Kawasaki KX 3 <sup>rd</sup> Miguel Farrajota – TM Enduro 250	<b>2000</b>	1 <sup>st</sup> Luís Serra – Yamaha YZ 250 2 <sup>nd</sup> Vítor Azevedo – Honda CRE 250 3 <sup>rd</sup> Pedro Afonso – Kawasaki KX 500
<b>2001</b>	1 <sup>st</sup> Paulo Gonçalves – Honda CR 250 2 <sup>nd</sup> Pedro Afonso – Yamaha WR426 3 <sup>rd</sup> Sandro Marcos – Honda CR 250	<b>2002</b>	1 <sup>st</sup> Luís Serra – KTM 520 EXC 2 <sup>nd</sup> Paulo Gonçalves – Honda CRF 450 3 <sup>rd</sup> Váiter Martins – KTM 125 EXC
<b>2003</b>	1 <sup>st</sup> Sandro Marcos – Suzuki 250 2 <sup>nd</sup> Pedro Afonso – Yamaha WR 450 3 <sup>rd</sup> Pedro Barradas – Honda CRF 450	<b>2004</b>	1 <sup>st</sup> Mário Patrão – Yamaha WR 450 2 <sup>nd</sup> Paulo Cardoso – Yamaha WR 450 3 <sup>rd</sup> Joaquim Norte – KTM EXC 520
<b>2005</b>	1 <sup>st</sup> Mário Patrão – Yamaha YZ 450F 2 <sup>nd</sup> António Maio – Yamaha YZ 250 LC 3 <sup>rd</sup> Paulo Gonçalves – Honda CRF 450	<b>2006</b>	1 <sup>st</sup> Mário Patrão – Suzuki RMZ 450 2 <sup>nd</sup> Rúben Faria – Yamaha YZ 450 3 <sup>rd</sup> António Maio – Yamaha YZ 450
<b>2007</b>	1 <sup>st</sup> António Maio – Yamaha YZ 480F 2 <sup>nd</sup> Mário Patrão – Suzuki RMZ 450 3 <sup>rd</sup> Tomás Neves - Yamaha WR 250F	<b>2008</b>	1 <sup>st</sup> António Maio – Kawasaki KX 450 F 2 <sup>nd</sup> Mário Patrão – Suzuki RMZ 450 3 <sup>rd</sup> Fernando Ferreira – Yamaha YZ 450 F
<b>2009</b>	1 <sup>st</sup> Mário Patrão – Suzuki RMZi 450 2 <sup>nd</sup> António Maio – Kawasaki KXF 450 3 <sup>rd</sup> David Megre – KTM EXC.F 250	<b>2010</b>	1 <sup>st</sup> António Maio – Yamaha YZ 450 F 2 <sup>nd</sup> Mário Patrão – Suzuki RMX - Z 3 <sup>rd</sup> David Megre – KTM EXC 450 R
<b>2011</b>	1 <sup>st</sup> António Maio – Yamaha YZ 450 F 2 <sup>nd</sup> Luís Oliveira – Yamaha YZ 125 3 <sup>rd</sup> Fausto Mota – Yamaha YZ 250 F	<b>2012</b>	1 <sup>st</sup> António Maio – Yamaha YZ 450 F 2 <sup>nd</sup> Mário Patrão – Suzuki RMZ 450 3 <sup>rd</sup> Hélder Rodrigues – Honda CRF 450
<b>2013</b>	1 <sup>st</sup> Mário Patrão – Suzuki RMZ 450 2 <sup>nd</sup> António Maio – Yamaha YZ 450 F 3 <sup>rd</sup> Pedro Afonso – KTM 500 EXC 510	<b>2014</b>	1 <sup>st</sup> Mário Patrão – Suzuki RMZ 450 2 <sup>nd</sup> António Maio – Yamaha YZ 450 F 3 <sup>rd</sup> João Vivas – Suzuki RMZ 450
<b>2015</b>	1 <sup>st</sup> Luis Oliveira – Yamaha YZ 2 <sup>nd</sup> Mario Patrão – KTM 450 SXF 3 <sup>rd</sup> Sebastian Bühler – Yamaha YZ 250F	<b>2016</b>	1 <sup>st</sup> Luis Oliveira – Yamaha YZ 2 <sup>nd</sup> Sebastian Bühler – Yamaha WR 450 F 3 <sup>rd</sup> João Lourenço – Sherco SEF R
<b>2017</b>	1 <sup>st</sup> António Maio – Yamaha WR 2 <sup>nd</sup> Luís Oliveira – Honda RX 3 <sup>rd</sup> Mário Patrão – KTM 450 EXC Factory	<b>2018</b>	1 <sup>st</sup> Sebastian Buhler – Yamaha WR 450 F 2 <sup>nd</sup> Bruno Santos – KTM EXC F 3 <sup>rd</sup> Martim Ventura – Yamaha WR 250 F
<b>2019</b>	1 <sup>st</sup> Sebastian Buhler – Husqvarna FC 450 2 <sup>nd</sup> António Maio – Yamaha WR Rally 3 <sup>rd</sup> Bruno Santos – Husqvarna FE	<b>2020</b>	1 <sup>st</sup> Sebastian Buhler – Hero Hero 450 Rally 2 <sup>nd</sup> Joaquim Rodrigues – Hero Hero 450 Rally 3 <sup>rd</sup> Bruno Santos – Husqvarna FE 500
<b>2021</b>	1 <sup>st</sup> António Maio – Yamaha WR450F 2 <sup>nd</sup> Gustavo Gaudêncio – Honda CRF4 3 <sup>rd</sup> André Sérgio – Yamaha WRF	<b>2022</b>	1 <sup>st</sup> António Maio – Yamaha WR450F 2 <sup>nd</sup> Martim Ventura – Yamaha WR450F 3 <sup>rd</sup> Gustavo Gaudêncio – Honda CRF450RX

## QUAD

<b>2000</b>	1 <sup>st</sup> Paulo Barbosa – Yamaha YFZ 350 2 <sup>nd</sup> Jordi Saborit – Honda TRX 400 3 <sup>rd</sup> Paulo Nobre - Honda TRX 400	<b>2001</b>	1 <sup>st</sup> Mário Reis - Honda TRX 400 2 <sup>nd</sup> Paulo Nobre - Bombardier GS 650 3 <sup>rd</sup> Jorge Esperto - Bombardier GS 650
<b>2002</b>	1 <sup>st</sup> Vítor Santos – Suzuki LT 400 2 <sup>nd</sup> José Clemente - Honda TRX 400 3 <sup>rd</sup> Paulo Nobre – Bombardier GS 650	<b>2003</b>	1 <sup>st</sup> Jordi Saborit - Bombardier GS 650 2 <sup>nd</sup> Vítor Santos – Suzuki LTZ 400 3 <sup>rd</sup> Nelson Caxias – Polaris Predator 500
<b>2004</b>	1 <sup>st</sup> João Lopes – Suzuki LTZ 450 2 <sup>nd</sup> António Moreira – Polaris Predator 500 3 <sup>rd</sup> Pedro Costa – Honda TRX 450	<b>2005</b>	1 <sup>st</sup> Rui Fernandes – Honda TRX 450R 2 <sup>nd</sup> Pedro Costa – Suzuki LTZ 400 3 <sup>rd</sup> Alexandre Oliveira – Suzuki LTZ 400
<b>2006</b>	1 <sup>st</sup> Nelson Caxias – Yamaha YFZ 450 2 <sup>nd</sup> Luís Engeitado – Yamaha YFZ 450 3 <sup>rd</sup> Simão Correia – Suzuki LTZ 400	<b>2007</b>	1 <sup>st</sup> Vítor Santos – Suzuki LTR 450 2 <sup>nd</sup> Paulino Cruz – Suzuki LTR 450 3 <sup>rd</sup> João Lopes – Suzuki LTR 450
<b>2008</b>	1 <sup>st</sup> Rui Mendes – Suzuki LTR 450 2 <sup>nd</sup> João Peraboa – Suzuki LTR 450 3 <sup>rd</sup> João Batista – Suzuki LTR 480	<b>2009</b>	1 <sup>st</sup> Humberto Pinto – Suzuki LTR 450 2 <sup>nd</sup> Roberto Borrego – KTM 525 XC 3 <sup>rd</sup> João Lopes – Suzuki LTR 450
<b>2010</b>	1 <sup>st</sup> Roberto Borrego – KTM 525 XC 2 <sup>nd</sup> João Lopes – Suzuki LTR 450 Z 3 <sup>rd</sup> Humberto Pinto – Suzuki LTR 450	<b>2011</b>	1 <sup>st</sup> Roberto Borrego – YFZ 450 2 <sup>nd</sup> António Moreira – Polaris Outlaw 525 3 <sup>rd</sup> Vítor Santos – Kawasaki KFX 450
<b>2012</b>	1 <sup>st</sup> Roberto Borrego – Yamaha YFZ 450 R 2 <sup>nd</sup> Rui Cascalho – Yamaha YFZ 450 R 3 <sup>rd</sup> André Mendes – Suzuki LTR 450 B	<b>2013</b>	1 <sup>st</sup> André Carita – Suzuki LTR 450 2 <sup>nd</sup> Vítor Santos – Yamaha 450 R 3 <sup>rd</sup> Luís Enjeitado – Polaris MXR 450
<b>2014</b>	1 <sup>st</sup> Luís Enjeitado – Yamaha YFZ 450 2 <sup>nd</sup> Rui Cascalho – Yamaha YFZ 450 R 3 <sup>rd</sup> Ricardo “Antrax” Carvalho – Polaris MXR 450	<b>2015</b>	1 <sup>st</sup> Roberto Borrego – Yamaha YFZ 450R 2 <sup>nd</sup> André Carita – Suzuki LTR 450 3 <sup>rd</sup> Antonio Moreira – Yamaha YFZ 450R
<b>2016</b>	1 <sup>st</sup> Roberto Borrego – Yamaha YFZ 450R 2 <sup>nd</sup> Rodrigo Pagaime – Yamaha YFZ 450R 3 <sup>rd</sup> Vítor Caeiro – Yamaha YFZ	<b>2017</b>	1 <sup>st</sup> Roberto Borrego – Yamaha YFZ 450R 2 <sup>nd</sup> Filipe Fernandes – Kawasaki KFX 450R 3 <sup>rd</sup> Vítor Caeiro – Yamaha YFZ-R
<b>2018</b>	1 <sup>st</sup> Roberto Borrego – Yamaha YFZ 450R 2 <sup>nd</sup> Jacinto Lourenço – Moto Start TR 3 <sup>rd</sup> Pedro Silva – Yamaha YFZ	<b>2019</b>	1 <sup>st</sup> Roberto Borrego – Yamaha YFZ 450R 2 <sup>nd</sup> Ruben Alexandre – Yamaha YFZ 450 R 3 <sup>rd</sup> André Carita – Suzuki LTR
<b>2020</b>	1 <sup>st</sup> Ruben Alexandre – Yamaha YFZ 450R 2 <sup>nd</sup> Fábio F. Ferreira – Yamaha YFZ 450 R 3 <sup>rd</sup> Filipe Silva – Suzuki LTR	<b>2021</b>	1 <sup>st</sup> Luis Fernandes – Yamaha YFZ 450R 2 <sup>nd</sup> Luis Engeitado – Yamaha YFZ 450 R 3 <sup>rd</sup> Flávio Gonçalves – Yamaha YFZ 450
<b>2022</b>	1 <sup>st</sup> João Vale – Yamaha YFZ 450R 2 <sup>nd</sup> Luis Fernandes – Yamaha YFZ 450R 3 <sup>rd</sup> Filipe Silva – Suzuki LTR 450		

## UTV

<b>2008</b>	1 <sup>st</sup> António Val – Dazon 1100 D 2 <sup>nd</sup> João Nascimento/Nuno Soares – Dazon 1100 D	<b>2009</b>	1 <sup>st</sup> Jorge Monteiro – Polaris RZR 800 2 <sup>nd</sup> Nuno V. Uden/Miguel Chaves – Polaris RZR 800 3 <sup>rd</sup> Rui Castanheira – FBF 1100
<b>2010</b>	1 <sup>st</sup> Carlos Esteves/Hélder Amado – Polaris RZR 756 2 <sup>nd</sup> Tiago Cunha – Rage R 140T 1049 3 <sup>rd</sup> José Vitória/Luís Vitória – Polaris RZR-S	<b>2011</b>	1 <sup>st</sup> Jorge Monteiro – Polaris RZR XP 850 2 <sup>nd</sup> Marco Grilo – Polaris RZR 900 3 <sup>rd</sup> Rui Serpa – Rage R140T 1050
<b>2012</b>	1 <sup>st</sup> David Além – IPS R7 2 <sup>nd</sup> João Lopes/Bruno Santos – IPS RZR 900 3 <sup>rd</sup> Teófilo Viñaras – Polaris RZR 900	<b>2013</b>	1 <sup>st</sup> Nuno Tavares – IPS RX 875 2 <sup>nd</sup> Aristides Mafra – Polaris RZR 900 XP 3 <sup>rd</sup> Roberto Viñaras/Cristobal H. – Polaris RZR 900
<b>2014</b>	1 <sup>st</sup> João Lopes/Bruno Santos – Polaris RZR 1000 2 <sup>nd</sup> Teófilo Viñarás – Polaris RZR 900 3 <sup>rd</sup> Carlos Miranda/Luís Gomes – Polaris RZR 900	<b>2015</b>	1 <sup>st</sup> João Dias/João Miranda – Polaris RZRXP1000 2 <sup>nd</sup> Pedro Santinho Mendes – Polaris RZR 3 <sup>rd</sup> João Lopes/Bruno Miguel – Polaris RZRXP

## BUGGY

<b>2010</b>	1 <sup>st</sup> António Val/Cristina C. – Dazon Re-1100D 2 <sup>nd</sup> Pedro Ramilo/Alcides Calçada – Semog 1100 3 <sup>rd</sup> Rui Castanheira – FBF Nani Ny 1100	<b>2011</b>	1 <sup>st</sup> Gonçalo Porêlo/Rui Porêlo – Semog 1000 2 <sup>nd</sup> Luís Ramalho – Nanyi NY 1083 3 <sup>rd</sup> António Brás – FBF DS 1100
<b>2012</b>	1 <sup>st</sup> João Guilherme - IPS R7 2 <sup>nd</sup> Luís Caseiro - IPS R7	<b>2013</b>	1 <sup>st</sup> António Ferreira/Hélder B. – Rage Sports 1300 2 <sup>nd</sup> Daniel Russo/Luís Silva – Nnyi NY 1100 3 <sup>rd</sup> Deborah Almeida – Dazon RE 1100
<b>2014</b>	1 <sup>st</sup> Bruno Martins – Rage Comet R 1400 2 <sup>nd</sup> João Lota – Dazon Jb Racing 1300 3 <sup>rd</sup> Pedro Perino/Nuno M. – Rage Comet R 1400	<b>2015</b>	1 <sup>st</sup> Daniel Russo – PRT Nanyi NY

## UTV/BUGGY

<b>2016</b>	1 <sup>st</sup> João Silva/Marco Silva – Yamaha YXZ 1000 2 <sup>nd</sup> Pedro Mendes – Polaris RZR 3 <sup>rd</sup> Stephane Peterhansel/Andrea P. - Yamaha YXZ
-------------	---

## SSV

<b>2017</b>	1 <sup>st</sup> Rúben Faria/Pedro Velosa – Can-Am Maverick X3 RS 2 <sup>nd</sup> Stéphane Peterhansel/Andrea Peterhansel – Yamaha YXZ 1000S 3 <sup>rd</sup> Bruno Martins/Eurico Adão – Can-Am Maverick X3 RS	<b>2018</b>	1 <sup>st</sup> Marco Pereira/Eurico Adão – Can-Am Maverick X3 RS XRS 2 <sup>nd</sup> Vitor Santos/Gregório Pereira – Can-Am Maverick X3 XRS TURBO 18 3 <sup>rd</sup> Dirk Von Zitzewitz/Andrea Peterhansel – Can-Am Maverick
<b>2019</b>	1 <sup>st</sup> Pedro Carvalho/André Guerreiro – Can Am Maverick X3 2 <sup>nd</sup> Santinho Mendes - Can Am Maverick X3 3 <sup>rd</sup> João Monteiro/Manuel Pereira - Can Am Maverick X3 XRS	<b>2020</b>	1 <sup>st</sup> João Dias – Can Am Maverick X3 2 <sup>nd</sup> Alexandre Pinto/Fábio Belo - Can Am Maverick X3 3 <sup>rd</sup> Roberto Borrego/Nuno Abrantes - Can Am Maverick X3 XRS
<b>2021</b>	1 <sup>st</sup> Gonçalo Guerreiro – Can Am XRS 2 <sup>nd</sup> Alexandre Pinto – Bombardier Can Am Maverick 3 <sup>rd</sup> Armindo Araújo/Beatriz Pinto – Bombardier Maverick	<b>2022</b>	1 <sup>st</sup> Gonçalo Guerreiro/Fernando Mendes – Can Am XRS 2 <sup>nd</sup> João Monteiro/Nuno Morais – Can Am X3 3 <sup>rd</sup> Luis Cidade/Pedro Mendonça – Can Am XRS

## ART.1 – INTRODUCTION

- 1.1. The Automóvel Club de Portugal (ACP) organizes the **37<sup>th</sup> BAJA PORTALEGRE 500**, from 26th to 28th of October 2023. This event is a part of the Portuguese Cross-Country Championship and occurs simultaneously with a car event (FIA World Cup for Cross Country Bajas).

Others

- Yamaha YXZ1000R European Cup Superfinale (SSV)
- Mini Baja FMP (national évent)

### Visa details – FMP

FMP Approval No – [approved on 28-08-2023](#)

Modification, amendments and/or changes to these Supplementary Regulations will be announced only by numbered and dated Bulletins issued by the Organizer and approved by the FMP Jury.

## 1.2. Description of the Event

- October 25, accreditations, and service park installation.
- October 26, accreditations, and administrative and technical checks;
- October 27, the Leg 1 includes a Prologue (SS1) of approx. 5 km and SS2 of approx. 70 km
- October 28, the Leg 2 include the SS3 of approx. 320km. Every 85km, maximum, areas of refuelling or service will be placed.

The route shall be kept secret. Only SSV have a SS Road Book. The route is marked with arrows, plastic tape and some paints for the Bikes and Quads.

For Bike and Quad roadbooks will be handed out just for liaison sections.

Average altitude of the total distance of the SS's is 500 meters.

## 1.3 Route Conditions (Selective Stages)

Gravel/dirt tracks 100,00 %

## ART.2 – ORGANISATION

### 2.1 Organiser's name, address, and contact details

**Automóvel Club de Portugal**

**ACP Motorsport**

Rua General Humberto Delgado, 3

2685-340 Prior Velho – Portugal

Tel.: + 351 219 429 187

E-mail: [acpmotorsport@acp.pt](mailto:acpmotorsport@acp.pt)

Fax: + 351 219 429 192

Website: [www.acp.pt](http://www.acp.pt)

## 2.2 Event Location

### NERPOR

Campo da Feira

7300 Portalegre

Phone: +351 219 429 187

Fax: +351 219 429 192

E-mail: [acpmotorsport@acp.pt](mailto:acpmotorsport@acp.pt)

Website: [www.bajaportalegre500.pt](http://www.bajaportalegre500.pt)

GPS: N 39° 16. 394' – W 07° 25. 266'

## 2.3 Official Notice Board – Location

26<sup>th</sup> to 28<sup>th</sup> October:

[www.bajaportalegre500.pt](http://www.bajaportalegre500.pt)

Sportity

Password: **BAJA500MOTO**

## 2.4 Secretariat

- Until 23<sup>rd</sup> October at the ACP Motorsport offices in Prior Velho (Art. 2.1), from 09h00 to 18h00
- From the 24<sup>th</sup> to the 28<sup>th</sup> of November at NERPOR (Art. 2.2)

## 2.5 Organising Committee

<b>Chairman</b>	Carlos Barbosa
<b>Vice President</b>	Marta Barbosa
	João Mendes Dias
	João Jordão
<b>Route Director</b>	Orlando Romana
<b>Route Supervisor</b>	Jaime Santos
<b>Secretary of the Event</b>	Vanda Marcelo

## 2.6 Stewards of the Meeting, Jury

<b>President</b>	José Rita
<b>FMP Member</b>	Guilherme Oliveira
<b>ACP Member</b>	Eduardo Rovisco
<b>Secretary of the Stewards</b>	TBA

## 2.7 Technical Delegates

<b>FMP Technical Delegate</b>	José Gaspar
	Diogo Oliveira

## 2.8 Senior Officials

Clerk of the Course (CoC)	Márcio Santos
Assistants of the CoC	Eduardo Rovisco
	TBA
Chief Security Officer	Jaime Santos
Chief Medical Officer (CMO)	Dr. Pedro Barradas

Event Secretary	Vanda Marcelo
ACP Environmental Steward	TBA
Responsible for Event's Logistics	Nuno Vieira
Media Relations	Marco Barbosa
Results (Cronobandeira)	TBA
Timekeepers	TBA
	TBA
Technical Stewards	Nuno Castel-Branco
	Pedro Corrula
	Eduardo Botelho
	Tiago Carvalho
	José Figueira
Competitors' Relations Officer	Eduardo Rovisco
	TBA
Service Park co-ordinator	Filipe Santos
Services of SS (ZA) Coordinator	Hugo Lourenço

## 2.9 Identification of the Officials and Marshals

Clerk of the Course	White Shirt
Timekeepers	Blue tabard
Safety Marshals	Yellow tabard
CRO	Red tabard
Scrutineers	Black tabard
Medical	Identified blue clothing
Media	Green tabard





## ART.3 – PROGRAMME

<b>Monday, August 28</b>		
18h00	Opening date for entries	Website
	Publication of Rally Guide	Website
	Publication of Supplementary Regulations	Website

<b>Monday, October 2</b>		
18h00	Closing date for entries with reduced fees	Website

<b>Monday, October 9</b>		
18h00	Closing date for entries	Website

<b>Friday, October 20</b>		
18h00	Publication of the entry list	Website/Sportity

## RALLY WEEK

<b>Wednesday, October 25</b>		
10h00/22h00	Accreditations	Stadium

<b>Thursday, October 26</b>		
07h00/20h00	Accreditations	Stadium
07h30/21h30	Rally Office opens	Nerpor
08h00/14h00	Administrative checks	Nerpor
09h00/15h00	Scrutineering	Nerpor
10h00/19h30	Media Accreditations	Stadium
10h00/19h30	Media Center opening hours	HQ (Nerpor)
10h00/16h00	Prologue (SS1) reconnaissance Road Book available on Sportity or Webside from 09h30m	Coutadas
16h00/19h00	Issuing of the road book SSV for section 1&2	Nerpor
16h00	1 <sup>st</sup> Jury Meeting	Nerpor
17h00	Briefing	Nerpor
18h00	Publication of the start list for Ceremonial Start	Website/Sportity
	Publication of the start list for Leg 1	Website/Sportity
19h00	Ceremonial Start	Jardim do tarro
20h30	Press conference	Jardim do tarro

<b>Friday, October 27</b>		
07h00/21h30	Rally Office opens	Nerpor
08h00/13h00	Accreditations	Nerpor
08h00/13h00	Media Accreditations	Near Stadium
08h00/20h00	Media Center opening hours	Nerpor
07h25	Start Leg 1	Nerpor
07h50	Start SS1	Coutadas
09H00	Publication of SS 1 results	Website/Sportity
09H30	Publication of starting order for Section 2	Website/Sportity
10h15	Start SS2	tba
11h00*	Arrival SS2	tba
13h00/18h00	Issuing of the road book for Section 3 (Cat. 3 - SSV)	Nerpor
15h00*	Arrival Leg 1	Nerpor
17h30	2 <sup>nd</sup> Jury Meeting	Nerpor
18h30	Publication of Leg 1 results	Website/Sportity
19h00	Publication of starting order for Leg 2	Website/Sportity

<b>Saturday, October 28</b>		
06h15/22h00	Rally Office opens	Nerpor
07h00/21h00	Media Center Opening Hours	Nerpor
08h40	Start Leg 2, Section 3	Nerpor
09h45	Start SS3	tba
13h45*	Arrival SS3	Coutadas
14h15*	Arrival Leg 2	Nerpor
16h45	Podiums Ceremony / Prize-giving	Nerpor
18h00	3 <sup>rd</sup> Jury Meeting	Nerpor
20h00	Publication of the provisional final classification	Website/Sportity
20h30	Publication of the final classification	Website/Sportity
20h30	Prize giving ceremony	Nerpor

\* Estimated time

**3.1** Official time throughout the entire rally will be that of GPS (UTC time + offset to local time).

#### **ART.4 – REGULATIONS**

In the event of difference in the interpretation of these regulations, only the Portuguese text will be considered as binding.

## ART.5 – CATEGORIES

<b>MTT1</b>	Bikes 2T	Up to 125 cc
	Bikes 4T	Up to 250 cc
<b>MTT2</b>	Bikes 2T	Equal to or greater than 150 cc up to 249cc
	Bikes 4T	Equal to or greater than 250cc up to 449cc
<b>MTT3</b>	Bikes 2T	Equal to or greater than 250cc
	Bikes 4T	Equal to or greater than 450cc
<b>MTT 4*</b>	Trail ou Big Trail	Bikes between 170kg / 210 kg
<b>MTT5*</b>	Maxi Trail	Bikes with more de 210kg
<b>ME</b>	Electric Bike	
<b>QUAD</b>	Quad	2 and 4 driving wheels
<b>SSV</b>	Atmospheric engines less than 2000cc or turbocharged engines less than 1000cc	
<b>SSV TT2</b>	Atmospheric engines less than 1000cc	
<b>SSV STOCK</b>	Atmospheric engines less than 2000cc or turbocharged engines less than 1000cc	

## ART.6 – LICENCES

### 6.1. Rider's Licences

According to Art. 70.2.1 of FIM Sporting Code and according to Art. 5 of the FMP Regulations.

## ART.7 – ENTRIES

The competitor enters the 37ª Baja Portalegre 500, in full awareness of the risks that he/she may take by participating in this event.

He/she agrees to indemnify, protect and hold harmless the Organizers, the FMNR and the FIM and anyone acting on their behalf or under their authority, including but not limited to their representatives, employees, agents, officials and volunteers, from and against any and all liability, penal and/or civil, loss, expense or claims of whatsoever nature, including but not limited to third party claims, relating to injury to persons, including death, or loss or destruction of or damage to property arising in connection with his/her participation in the 36ª Baja Portalegre 500.

The maximum number of crews that can entered is:

150 bikes  
40 quad  
60 SSV

## 7.1 Entries procedures

Anybody wishing to take part in the event must register online at: [www.bajaportalegre500.com](http://www.bajaportalegre500.com)

The truth and legality of the documentation provided by competitors is of his/her responsibility. The submission of false documentation will lead to the immediate exclusion of the competitor and possible disciplinary proceedings by FMP.

When entry, the following documents must be attached or sent by October 14, 2022, to the Organizer:

- Copy of identification document (CC or passport)
- Authorization from the Federation of pilots to participate in the race
- Copy of sports license (ref. to the Art. 6.1.)
- Copy of driving license
- Copy of vehicle document
- Copy of vehicle insurance

For the registration to be valid, proof of payment must be attached.

## 7.2 Entry fees

	Fee	
	Up to 2 October	Up to 9 October
<b>Bike / Quad</b>	627€	940€
<b>SSV</b>	1215€	1822€

**Competitors who refuse optional advertising, will pay an increase of 100% on the entry fee.**

### Information regarding VAT:

- Invoices issued to foreign companies are not subject to VAT (VAT- Reversed charge);
- Invoices issued to individuals from any nationality or to Portuguese companies are subject to VAT – tax rate of 23%.

**Payment methods:** PayPal and Credit Card

Included in the entry fees
Insurance of civil liability towards third parties
1 BIKE / QUAD sticker (access to Nerpor and the Services Areas)
1 SSV sticker (access to Nerpor and the Service Areas)
1 TEAM MANAGER sticker (access to Nerpor, Services Areas, and Start / Arrival of the SS)
1 Competitor(Bike/Quad) or 2 Competitors (SSV) Individual Pass
1 Team Manager individual passes (access to Secretariat)
4 Assistance individual passes
Rental of Anube STELA III (SSV and Quad) or SPICA III (bike) equipment (Vehicle to vehicle communication system, speed control zones, and GPS-GSM / Safety tracking system)
Road Book roll or notebook for SSV (upon competitor's choice at time of registration)

<b>Additional SERVICE stickers / Passes fees:</b>
---

EUR 600 – Truck
-----------------

EUR 400 - Auto / Van
----------------------

7.3 Without payment the entry will not be considered.

7.4 The date of reception of the entry fee will be considered to establish the entrant's list. The organization reserves the right to refuse the entry to pilots or teams that have been disqualified in previous editions of the race for unsportsmanlike behaviour.

### 7.5 Entry fee refunds

The entry fee shall be refunded in full

- if the event does not take place
- to teams whose entry application is rejected

The organiser may partially refund entry fees, if a competitor cannot take part in the event due to a duly proved case of force majeure, subject to the application reaching the organiser per email.

The deduction will be:

- 25 % of the entry fees for requests received until 30 days before the administrative checks
  - 50 % of the entry fees for requests received until 8 days before the administrative checks
- There will always be a deduction of 25% (file fee).

Other situations of *force majeure* not mentioned are subject to analysis and approval of the Organising Committee.

## ART.8 – INSURANCE

According to Art. 110.1.1 of the FIM Sporting Code.

8.1 Automóvel Club de Portugal, as well as the Organizing Committee, declines all responsibility for any accident that may occur during the 36th edition of the Baja Portalegre 500.

## ART.9 – IDENTIFICATION

9.1 The organizer will provide each competitor with 3 plates with the competition numbers, 2 advertising plates and 1 bib with the race number.

9.2 All plates must remain throughout the whole event according to Appendix I. The use of the bib during the whole event is compulsory.

9.3 If at any moment of the event a bib and/or plate are missing or wrongly fixed the penalty will be:

<b>First infringement</b>	1 hour time penalty
<b>Second infringement</b>	Exclusion

- 9.4 An identification bracelet will allow you to recognize the pilots. This bracelet will be placed at the accreditation (next to the football stadium, near to NERPOR), and cannot be removed until the end of the race or until the moment the pilot has given up or been disqualified. Finding, at any time during the race, that the wristband is missing, will result in disqualification.

## ART.10 – ADVERTISING

- 10.1. The spaces reserved for the organizer for mandatory and non-negotiable advertising are (see Annex I):
- 3 plates of 18x22 cm plates with competition numbers
  - 1 Bib (30x30 cm cloth plate) to be placed on the rider's dorsal area. free fixation
  - 2 Race Plates (10x21 cm)
  - SSVs must place two fixed vertical plates at the rear of the vehicle, on both sides, according to Art. 8.4 of the FMP RCNTT

Plates and bibs provided by the organization cannot be altered (cut out, etc.) and must be visible and legible throughout the course of the race.

- 10.2. The compulsory advertisement is: **BP / PORTALEGRE / PONTE DE SOR**

## ART.11 – TRAINING AND RECONNAISSANCE

- 11.1. Start will be denied to all crews detected by members of the Organizing Committee while training on the racetracks. The race will take place in the municipalities of: Alter do Chão, Abrantes, Crato, Extremoz, Fronteira, Gavião, Monforte, Nisa, Ponte de Sor, Portalegre and Sousel.

## ART.12 – ITINERARY

- 12.1. The official itinerary is defined by the Road Book and for the arrows, tapes, and paintings. It is absolutely forbidden to competitors out of the itinerary, unless in the event of a track obstruction otherwise, **the penalty may go to exclusion**. In such a case, the competitor may pass around the obstacle and go back to the itinerary immediately after.

The participants of the 37<sup>th</sup> Baja Portalegre 500 will be monitored by Spica III or Stella III control equipment. Those who make cuts or shortcuts on the course will be sanctioned. It is mandatory to pass through all the areas defined by signage and Road Book.

It is considered a cut or shortcut whenever a vehicle leaves the marked course (natural limits of rural, forest and private roads, boundary paths of agricultural fields, etc...)

The calculation of the difference in distance (in meters) between the route set by the organizer and the route taken by the vehicle in competition, incurs a penalty calculated as follows. Each unit of distance (meter) calculated on the previous difference is given a penalty of 10 seconds.

Riders must maintain a respectful attitude towards the environment, forest and private roads, farms, and comply with the highway code when driving on public roads.

## ART.13 – ADMINISTRATIVE CHECKS

### 13.1. Location

The Administrative checks will take place on October 26.

Location: NERPOR

Schedule: will be published in a Bulletin.

### 13.2. Original documents to be presented

- Sporting License according to the Art. 6.1
- Rider's ID;
- Vehicle owner authorization documentation (if not the owner);

### 13.3. Time controls

All the entrants must present themselves according to the established timetable. Any delay at the presentation will result in the following fines:

from 1 to 15 minutes	150 €
from 16 to 30 minutes	250 €
> 30 minutes	Start may be denied

## ART.14 – SCRUTINEERING

### 14.1. Location

Scrutineering will take place on October 26. The exact location and schedule will be published in a Bulletin.

#### Timetable

According to the program. The exact schedule will be published by means of a bulletin.

### 14.2. Technical scrutineering for bikes and quads include:

- Placing of advertising;
- Number plates;
- Front lights and stop with fixed and final installation (must be nourished always by an alternator powered by motorcycle engine);
- Vehicle registration plate;
- Frame number (must match the registration);
- Protection pad located in the middle of the handlebars;
- Helmet

### 14.3. Technical scrutineering for SSV include:

- Placing of advertising;
- Number plates (should be placed in a "quad type flag" which should be fixed at the highest point of the vehicle structure or on the back);
- Front lights and stop with fixed and final installation;
- Battery switch operation;

- Fitting of safety-belts;
- Placement of the lateral protection nets;
- Plate number;
- Frame number (must match the registration);
- Helmet, Hans and Fireproof Clothing

14.4. All the entrants must present themselves with their vehicle according to the established timetable.

Any delay at the presentation will result in the following fines:

<b>from 1 to 15 minutes</b>	150 €
<b>from 16 to 30 minutes</b>	250 €
<b>&gt; 30 minutes</b>	Start may be denied

14.5. After completing scrutineering, vehicles must be driven by one of the drivers or a team representative to the ceremonial start holding area.

14.6. Any delay at the entrance of the Parc Fermé will result in the following fines:

<b>from 1 to 15 minutes</b>	150 €
<b>from 16 to 30 minutes</b>	250 €
<b>&gt; 30 minutes</b>	Start may be denied

14.7. Additional checking of the vehicles/documents may be carried out at any time during the race. Any rider refusing his vehicle/documents to be checked will be subject to a penalty, which can lead to exclusion, after decision of the Jury.

14.8. The rider is the only responsible for the posting of any identification mark on the vehicle and it's his/her only responsibility to guarantee his/her protection until the end of the event. Should it be missing, the vehicle will be immediately excluded from the race.

14.9. A complete scrutineering involving the dismantling of the vehicles in the first places of the general classification and/or each class, may be carried out at the absolute discretion of the Jury of the meeting or following a protest or upon the decision of the clerk of the course.

## ART.15 – SERVICE AREAS (ZA) AND REFUELLING AREA (GAS)

**THE MAXIMUM SPEED PERMITTED IN THE SERVICE AREAS (ZA) (including NERPOR) and GAS (refuelling only) is 30 km/H.**

**Speed control will be performed by the Stella III (SSV and Quad) and Spica III (Bike) devices, Appendix V.**

15.1 Repairs are free on the road sections and permitted on the selective sections under the following conditions:



- a) At any point of the SS:
  - By the rider concerned;
  - By any other rider in normal racing conditions.
- b) At the service areas (ZA):
  - By the rider concerned;
  - By any other rider in normal racing conditions;
  - By any other person identified as Service by the stickers supplied by the organization.
- c) At Nerpor and during liaisons (from Parc Fermé to the SS start and SS finish to Parc Fermé).
  - By the rider concerned;
  - By any other rider in normal racing conditions;
  - By any other person identified as Service by the stickers supplied by the organization (*Service is prohibited in the last 3km before the start of the SS and in the 1km after the end of the SS*)

**Any violation of the above rules will incur a penalty defined by the Jury.**

- 15.2** The use of eco-friendly mats during refuelling is mandatory, as well as have a fire extinguisher of at least 5 kg. Non-usage of an eco-friendly mat implies the **5minutes** penalty. **The use of these mats at Parc Fermé is mandatory.**
- 15.3** The exact location of the service areas (ZA) and/or refuelling areas (GAS) will be a maximum of 85 km from each other and informed during the Briefing or by information distributed at the checks. The distance for each Service Area will be marked along the way by means of plates, every 10 km, indicating the number of kilometres – decreasing - to the nearest assistance.  
At GAS, only the refuelling is permitted.
- 15.4** There will a service with limited time before the end of Leg 1, Service A, after SS2 (3h00). **The 3 hours start at the entrance to the Service Area (time control 2B, Gate 2 of the Layout in Appendix VII) and end with the entrance to the Parc Fermé.**
- 15.5** Only the vehicles with a service sticker delivered by the organisation will be admitted at the service areas.  
These stickers should be visibly placed on the front windscreen. Each crew will receive 2 service plates free:
  - **BIKE / QUAD**, allows access to NERPOR, ZA and GAS to the SS.
  - **SSV**, allows access to NERPOR, ZA and GAS to the SS.
  - **TEAM MANAGER (ONLY FOR THE TEAMS)** allows access to NERPOR, ZA, GAS to the SS, and the start and arrival of the SS (*if is authorized*).
- 15.6** It is expressly forbidden to refuel with running engine. The non-compliance with this rule will incur into a **penalty of 30 min.**, in case of recurrence to exclusion.

- 15.7** It is expressly forbidden to refuel outside the service areas, ZA or GAS. The observance by members of the Organization of the non-compliance of this article implies into disqualification.
- 15.8** The fuel transport in tanks that are not fixed to the structure of the vehicle is prohibited, resulting in a penalty of 30 minutes and in case of repetition to the disqualification.
- 15.9** **For the SSV** in any Service Area or GAS, located in the SS, it's required, the stop in a minimum period of 2 minutes. This time is controlled by Stella III system and this time is for the responsibility of the Rider. The 2 minutes starts when the vehicle is immobilized, in the service area, and this 2-minute stop, when the vehicle restart the march, in the same place.
- During refueling, no further intervention on the vehicle is permitted.
  - The Stella III equipment displays the countdown on the screen.
  - The engine must be Off when the vehicle is immobilized.
  - The non-compliance with this rule will incur into a penalty of 10 minutes for each infringement.

## **ART.16 – PROLOGUE (SS1) / RECONNAISSANCE / FIXED PENALTIES / MAXIMUM TIME OF THE SS**

- 16.1** The SS1 will take place on October 27, in form of a special stage with the length of aprox. 5 km. The time obtained at SS1 will serve to set the starting order for SS2. The starts for SS1 will be given in ascending order. Bikes first, followed by Quads and finally SSV. The reconnaissance of the SS1 may be done according to the schedule on the October 26, **between 10h00 and 16h00**, by foot, normal bicycle, or electric bicycle
- 16.2** It is absolutely forbidden to cut or short cut, and the riders must follow the route indicated by the arrows and plastic bands. Non-compliance with this rule will be punished with the penalty will be awarded by the Jury of the race. In the event of a run-off, riders shall return to the track at the same place.
- 16.3** If the route is blocked, riders can leave the route to go around the obstacle and must return to it immediately after. In no case whatsoever shall there be neutralization or a deduction concerning the time spent to do the itinerary. It will not be allowed to repeat the SS1.
- 16.4** The maximum time to run the SS1 will be 30 minutes.
- 16.5** The time set at the SS1 will count for the final classification.
- 16.6** In the event of a dead heat, the riders with the same time in the SS1 shall start for SS2, according to the order of their numbers.

- 16.7** The possible penalties registered at the different controls at Leg 1; do not influence the classification of the SS1, or the start to SS2.
- 16.8**
- a)** If a rider does not complete QSS1 within the time limit, he will be given the maximum time for the SS1 (30 minutes).
  - b)** If a rider does not participate in SS1, he will be given the maximum time to complete it (30 minutes), plus the planned times of the liaisons plus a fixed penalty of 30 minutes.
  - c)** Nevertheless, and in any of the circumstances mentioned above, the rider will be authorized to leave for the SS2 if he presents himself in the Parc Fermé that precedes it, until 10 minutes before the scheduled time and since the organizer is informed (CROs, [crobike.bajaportalegre@acp.pt](mailto:crobike.bajaportalegre@acp.pt), or by mobile, see appendix IV) of the intention to participate in the SS2 up to 30 minutes before the scheduled time for publication of the start list (as per schedule).  
This rule applies also to breakdowns in binding sectors provided the mentioned procedures are followed.
  - d)** If a rider does not complete the SS2 within the time limit, he will be given the maximum time set for the SS plus the planned times for liaisons not made, plus a fixed penalty of 60 minutes.
  - e)** If a rider does not participate in SS2, he will be assigned the maximum time set for the SS, plus the planned times for liaisons not made, plus a fixed penalty of 120 minutes.
  - f)** Nevertheless, and in any of the above circumstances, will be authorized from Leg 2, provided that the respective motorcycle enters the Parc Fermé (Nerpor), at the normal time of operation of the same, or in the 10 minutes before the time of the first competitor (bike/quad or SSV) to the start of Leg 2 and provided that he informs the organizer (CRO) of his intention to participate in the next stage up to 30 minutes before the scheduled time for publication of the list with the starting times for the start of the stage.
  - g)** In all situations the riders must start Leg 1 or remove their vehicle from the Parc Fermé (Nerpor).  
Should this not be possible, the competitor must submit a request to the Jury, requesting participation in Leg 2, even if not taking the bike out of the Parc Fermé at Leg 1. If accepted, a penalty to be defined by the Jury will be applied, which will always be higher than those for the cases mentioned above.  
The riders covered by this rule will go to the respective selective sector or step after the classified riders, in ascending order of their competition numbers.
- 16.9** In the event of a dead heat, at the end of the race will be decided in favour of the competitor who has achieved the best time on SS1. If it prevails, it will favour the first rider to get the best time on SS1.

## 16.10 Maximum Time and Fixed Penalties of the SS's

SS	KM	Maximum Time	Fixed Penalty
SS1 (Prologue)	5	30m	30m
SS2	70	120m	60m/120m
SS3	320	430m	120m

### ART.17 – BRIEFING

- 17.1 The briefing will be written and delivered during administrative checks and published on the official board on the website and sportity.

### ART.18 – STARTING ORDER

18.1 The start for the Leg 1 and for the SS1, will be given in ascending order of the competition numbers. Bikes first, followed by Quads and finally SSV.

18.2 The start for SS2 will be given according to the classification obtained in SS1. Bikes first, followed by Quads and finally SSV.

- 18.3 The start for Leg 2 will be given according to the classification obtained with the sum of the results obtained in SS1 and SS2 plus the hypothetical sports penalties. Bikes first, followed by Quads and finally SSV.

The Clerk of the Course may, for reasons of force majeure, change the order provided.

- 18.4 Liaisons and transport (see distances in Appendix IV):  
All liaisons must be made using the competition vehicles, the use of trailers or vans is prohibited.
- 18.5 Any delay in the presentation at the start of any of the Stages (leaving the Parc Fermé) will be penalized with one minute for each minute of delay. A maximum delay of 15 minutes will be allowed. The start will be refused to any rider who is delayed.

### ART.19 – TIME CONTROLS

According to Art. 18 of the FMP Regulations 2023.

### ART.20 – SELECTIVE SECTIONS / ROUTE MARKING / PASSAGE CONTROL / INTERRUPTION OF SS / SPEED CONTROL ZONES / TYRES / NEUTRALIZATION / OTHER PROCEDURES

- 20.1 During a selective section, assistance is allowed as per article 15 of the present regulations.
- 20.2 Any rider refusing to start in a selective section at the time and in the position allocated to him/her shall be given a penalty which can lead to exclusion.

**20.3** A maximum time will be given to run every selective section. This time will be published by bulletin and must not be exceeded; otherwise, it can lead to exclusion.

**20.4** The closing time of the different controls of the selective section will be calculated as follows:

$$T_n = T_o + T_m + 60 \text{ minutes}$$

**T<sub>n</sub>**: Closing time of the control "n"

**T<sub>o</sub>**: Starting time of the last vehicle

**T<sub>m</sub>**: Maximum time at control "n" calculated according to the distance from the starting point and the minimum speed average established for the selective section.

### 20.5 Route Marking

Liaison section road books will be delivered to each competitor. The routes of SS's will be indicated by arrows, tapes, and paintings; there are no road book available (except Cat. 3).

The arrows will be placed as follows:

- Placement of **red plates with white arrow**, **100 m before crossroads** (pre-indication of direction change)
- Placement of **yellow plates with black arrow** on the location of a change of direction
- Placement of plastic tapes (red and white ACP) **on the right side of the route**, normally every 400 m (should a competitor get lost, it will be easier to identify the correct direction, when returning to the route)
- Placement of plastic tapes to close the routes which are not to be used, and one yellow plate with a X, for the close routes
- Placement of plastic tapes "red and white" at dangerous places.
- Placement of plates with diverse information concerning possible danger (holes, wired fences, jumps, rivers, stones, etc.)
- Placement of plates with different information (CC, radios of the organisation, CP, distance to the next ZA)

### 20.6 Cross Roads Controls

- a) Controls will be set up in the intersection with asphalt roads or heavy traffic ways.
- b) these controls will be signalized as follows:
  - **CC (plate on place, with the number of the cross road)**
- c) Riders must respect the signs, namely the stop signs shown by the marshals, can result in exclusion. The vehicle must stop at these controls, unless otherwise indicated by the marshal.

### 20.7 Passage Control (PC)

- a) To check that the crews are respecting the circuit, passage controls will be set up along the course. The riders must stop at these controls.
- b) The control zone will be indicated by means of standardized signals:
  - warning sign on a yellow background (beginning of the control area)
  - sign on a red background (position of the control post)

- final sign on a beige background with three black transverse stripes (end of the control area)
- c) At the PC, riders may present themselves at any moment (within the limits ruled by article 20.4). The passage time will be registered on a plastic time card. Even in case of lack of the card, it is mandatory to stop at the control.
- d) In the compulsory passage controls, will be applied the speed control of 30 km/h. This start in the beginning of the Passage control (warning sign on a yellow background), until the end (sign on a beige background with three black transverse stripes). **The presentation of the time card in these passage controls is the responsibility of the Rider. The same responsibility is applied for the fixation of the time card in the vehicle. If the Rider don't show the time card in a passage control, it will be applied 2 minutes' penalty for each control. If the Rider don't have the time card, the registration will be in his dorsal.**  
In any cases, the responsibility of the Rider is verifying the registration of the passage control of the timekeeper is correct in a visible place and permanent.
- e) The lack of a registration in the time card or non-passage at a time control will incur into disqualification of the rider.
- f) Any rider not stopping at a time passage control shall be given a penalty as laid out below:

<b>First infringement</b>	5 minutes
<b>Following infringements</b>	10 minutes for each offence

- g) The number, location and closing time of the passage controls will be published by an amendment.

## 20.8 Interruption of a selective section

According to the spirit of this kind of event, crews are subject to unforeseen factors, which will have to be overcome by each one. Especially in the case of partial or total road obstruction by any kind of obstacle (for example: a car, a stream with too much water) it is up to the crews presenting themselves at such a point to try to clear the track and help the crews in trouble.

There will be no deductions regarding the time spent to run the circuit due to such conditions.

Nevertheless, bearing in mind the special conditions of this kind of event, and in rare occasions as a serious accident or a deep change of the weather conditions or any other case of exceptional nature, the rally may be interrupted.

Should this happen, the following procedures will be taken:

- ## 20.9
- In a selective section the course between two successive time controls shall be defined as a "sub-section". A sub-section will be any part of the circuit of the selective section between:

- a) The starting time control and the first passage time control;
- b) Two successive passage time controls;

- c) Any time control (start or passage) and an eventual passage time control (emergency) set up as per decision of the clerk of the course for regrouping or neutralization.
- d) A new starting time control (emergency) resulting from the race's neutralization (as per the previous item) and the time control (passage or arrival) immediately after;
- e) The last passage time control and the arrival time control at the end of the selective section.

**20.10** The interruption of a selective section may affect:

- a) The whole selective section if there are no passage time controls
- b) A single sub-section

**20.11** In the case foreseen in Art. 20.8 the Jury of the race will determine that the classification in the selective section for those competitors who could not run the sub-section in normal racing conditions will be the sum of the times registered:

- between the start time control of the selective section and the time control where the race was interrupted;
- between the new start time control and the arrival time control at the end of the selective section and the imaginary time attributed to the sub-section that was not entirely covered by all competitors.

**20.12** To the competitors having covered the whole of the selective section (without interruption) the time considered will be the time set between the start time control and the arrival time control of the selective section.

**20.13** Should the Jury of the race, by reasons of force majeure (superior force), decide to withdraw a sub-section in which the sporting truth was not respected, the classification in the selective section will be equal to the sum of the times set:

- between the start time control and the passage time control immediately before the point where the race was interrupted;
- and between the passage time control immediately after the point where the race was interrupted and the arrival time control of the selective section.

In this case, a new start of the selective section should be given at the passage time control immediately after the point where the interruption took place.

To those competitors having covered the whole of the circuit without any interruptions, the time set by each one, between the passage time controls immediately before and after the point of interruption, shall be deducted from their total time set.

**20.14** These procedures can be adopted besides the number of competitors that have done the passage in race conditions or that have been affected by the interruption of the race, this means, that have or haven't passed the obstacle or alteration of track that motivated the lock in of the other competitors.

**20.15 Permitted early check-in**

V4 (park fermé after the scrutineering), TCS1, TC1B, TC2B, TC2C, TC3B

## 20.16 Classification

The final classification will not be distributed after the event. The final classification will be published on the website on the Digital Notice Board: [www.bajaportalegre500.com](http://www.bajaportalegre500.com) or Sportity.

## 20.17 Speed Control Zones

For the control of these zones the Anube Stella III system will be used. The start of the speed zone control will be indicated in the Road Book by a box marked "SZ" and the maximum speed authorized. The end of the speed control will be indicated in the Road Book by a box marked "FZ". Panels will also be placed at the beginning and end of each zone, together with others informing the maximum allowed speed. These panels are for reference only, have no regulatory validity, the information given by the Anube equipment will prevail.

## 20.18 Speed Control Zones Penalties

According to Art. 12.5 of the FMP Regulations.

## 20.19 Tyres

In accordance with Art. 47.05 from FIM Bajas Technical Rules.

## 20.20 Neutralisation / Transfer

Time that competitors are neutralized, by decision of the Clerk of the Course, in a parc fermé regime.

A neutralization can be used in the following moments:

- Liaisons between SS (Transfer)
- Time of refuelling

If the refuelling is within a neutralization between SS's, the time allowed between the end of one SS and the departure of the next SS, will consider the distance to be made between the two locations and the time of refuelling (10 minutes).

### Procedures:

The arrival of the SS is made for the Stella III or Spica III.

The start for the next SS is the pilot's responsibility.

The Stella III or Spica III will indicate, in decreasing form, the authorized time between the end of the SS and the sign with the yellow start flag clock placed 100m from the start to the next SS.

At the place of start, a sign with a red clock and another with the flag start of will be placed.

Between the yellow clock sign and the departure signs, competitors can only access 5 minutes before their start time.

Competitors must put themselves on the starting line and must only proceed when the hour indicated on the clock coincides with that of the competitor, hour, minute and second.

At the start, a digital clock will be placed to assist competitors.



The early start is subject to penalties to be defined by the Jury.

## ART.21 – SAFETY

### 21.1. Retirement / Exclusion

- a) In case of retirement, the rider must compulsorily give notice to the organising committee, as soon as possible.
- b) A retired rider or one that has been excluded must compulsorily leave the circuit and remove the plates with the race numbers from the vehicle, delivering the letter of withdrawal to the first official.
- c) Whatever the reason may be and namely in case of retirement of the crew it is absolutely forbidden to the service crews to enter the circuit before it has been opened to traffic.

### 21.2. Opening of the route

The organiser's sweeper vehicles will close the circuit after all the competitors have passed. They will provide transport for the riders whose vehicles may be damaged, but they will in no case be responsible for repairing or towing the damaged vehicles. The riders, who refuse to accept this transport, will be responsible for their own transportation.

### 21.3. Competitor Localization System Stella III and Spica III / SSV and Quads Overtaking System and Speed Control

The use of the Stella III (for Quad and SSV) and Spica III (for Bikes) localization system's is mandatory.

This system allows checking the position of each rider on the course. The equipment has a rental cost include of the entry fees.

The equipment also allows to check the time a rider stopped next to another rider for assistance. The time will be taken off at the end of the event. Therefore, the concerned rider shall request the correction of the time in written to the Clerk of the Course, which will be decided by the Jury. This stopping time will only be recovered if the reason for stopping is accident assistance and justified by the means of the organization that occurs to the place.

Instructions for use are described in the Appendix V of this regulation.

- 21.4 A second equipment, Spica III, will be distributed to the Bikes and Quad, this equipment must be carried by riders during the entire race, under penalty of 10 minutes for infraction.

## ART.22 – MEANS OF COMMUNICATION

- 22.1 The use of a mobile phone may be permitted to contact the organising committee in case of accident or emergency.

## ART.23 – PARC FERMÉ

- 23.1.** “Parc Fermé”: zone in which no repairs or intervention is possible, except in specific cases clearly determined by these regulations.
- 23.2.** Any infringement of the “Parc Fermé” rules shall result in a penalty of 1 hour to exclusion.
- 23.3.** As soon as the rider has parked his vehicle in the Parc Fermé, he/she must leave the Parc Fermé immediately and will not be allowed to re-enter it.
- 23.4.** To remove his/her vehicle from a Parc Fermé for the start of a leg or regrouping halt, the rider shall be allowed to enter the Parc Fermé 10 minutes before his starting time.
- 23.5.** Quads can only be moved with engine on inside the Parc Fermé under respect of a speed lower than 10 km/h and guaranteeing the security of third parties.
- 23.6.** After the conclusion of the rally, riders may remove their vehicles from Parc Fermé 30 minutes after the publication of the official classification. To remove the vehicle, the rider or his/her representative must present the identification bracelet.
- 23.7.** The surveillance of Parc Fermé will cease at 24h00m, October 28.

## ART.24 – PROTESTS / APPEALS

- 24.1** According to the Art. 27 of the FMP Regulations.

## ART.25 – PRIZE LIST

### 25.1 General Classification

General Classification Bike	1 <sup>st</sup> – 10 <sup>th</sup>	Trophy or cup
General Classification Quad	1 <sup>st</sup> – 5 <sup>th</sup>	
General Classification SSV	1 <sup>st</sup> – 10 <sup>th</sup>	
Categories	1 <sup>st</sup>	

## ART.26 – PRIZE GIVING CEREMONY

According to programme

## ART.27 – ENVIRONMENT

According to Art. 82.28 of the FIM Regulations 2023.

# APPENDIX I – ADVERTISING PLAN

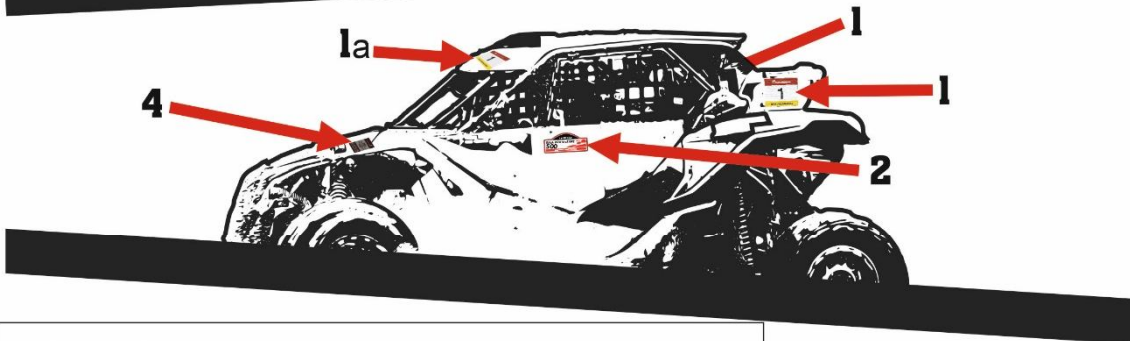
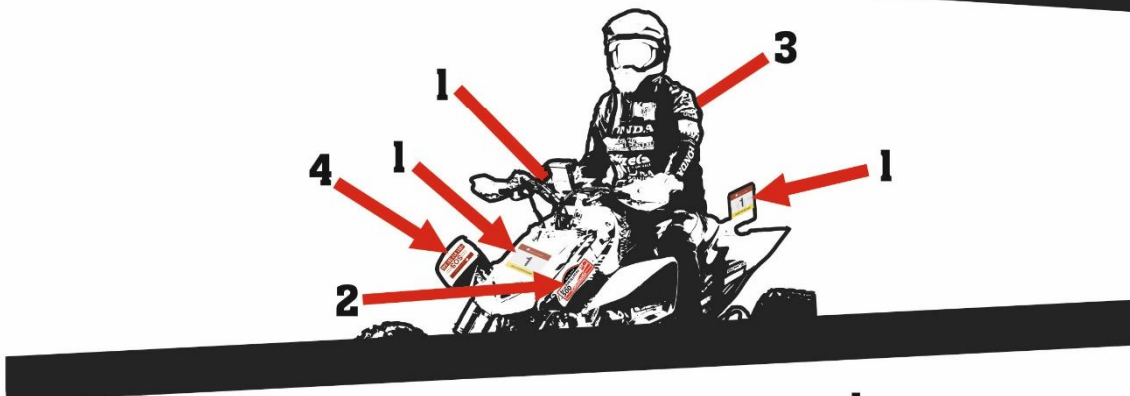
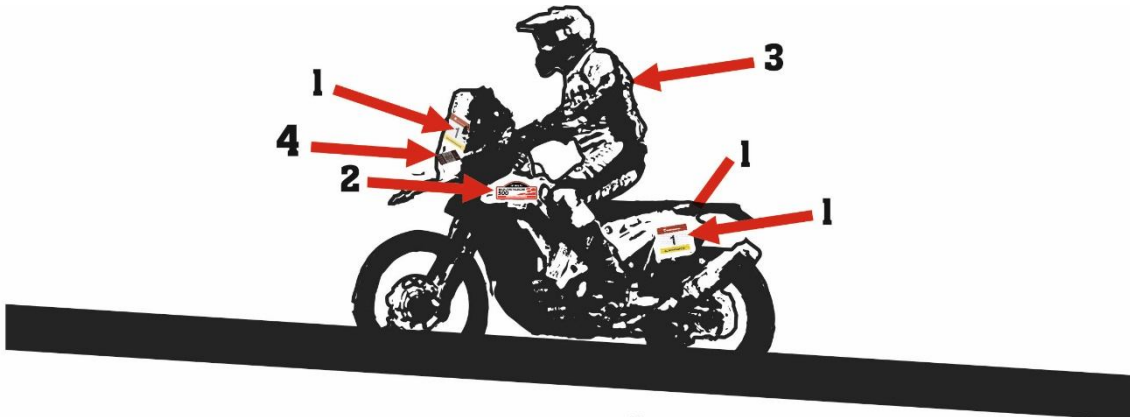

Subtitle:

- 1 - 3 panels (20x10 moto/quad and 27x20 SSV) with race number
- 1a - SSV race number (20x10)
- 2 - Proof Plates
- 3 - 1 Bib (Bikes and Quads)
- 4 - SOS number (must be placed in a conspicuous place)

**4** AUTOMÓVEL CLUB DE PORTUGAL  
 TELEFONE **SOS** EMERGENCIA  
 TELEPHONE EMERGENCY  
**+351 912 201 545**

## APPENDIX II – NAME AND PHOTOGRAPH OF THE COMPETITORS RELATION OFFICER AND THEIR SCHEDULES

---



**Eduardo Rovisco**  
Mobile (tba)

**Tba**  
Mobile (tba)

The CRO's will be available by phone or e-mail to avoid face to face contacts.

[crobike.bajaportalegre@acp.pt](mailto:crobike.bajaportalegre@acp.pt)

## APPENDIX III – EQUIPMENT

### 1 All riders should be equipped with:

- a) FIM homologated helmet
- b) Airbag System according to the FIM Standards (Art. 21.5 of the SR), chest and back protection according to the FIM Bajas Technical Rules
- c) Protection wear of suitable resistant material and covering all members.
- d) Gloves
- e) Competition boots
- f) Goggles
- g) GPS (Anube)
- h) Hans and fireproof clothing (SSV only)

## APPENDIX IV - ITINERARY

Cerimonial Start							Thursday, October 26	
Sunrise - 07:59							Sunset - 18:36	
TC	LOCATION	SS km	Liason km	Total km	Time	1st. Moto		
V4	Parc Ferme IN (Jardim do Tarro)				*			
CS0	Cerimonial Start					19:00		
CS1	Nerpor		3,67	3,67	00:30 *	19:30		
<b>totals</b>		<b>0,00</b>	<b>3,67</b>	<b>3,67</b>				

STAGE 1							Friday, October 27	
Sunrise - 08:00							Sunset - 18:35	
TC	LOCATION	SS km	Liason km	Total km	Time	1st. Bike		
0	START Section 1 / Leg 1 - NERPOR					07:25		
<b>km 0,3/0,5 - Possible Refuelling (commercial filling stations indicated in the road book)</b>								
1	TC Start QSS1		7,03	7,03	00:20	07:45		
<b>SS1 Prologue</b>		<b>3,71</b>				<b>07:50</b>		
1A	QSS1 STOP (Max Time - 30m)			3,71		07:55		
<b>km 69,37 - Possible Refuelling (refuelling provided by the team)</b>								
<b>km 70,13 / 70,48 - Possible Refuelling (commercial filling stations indicated in the road book)</b>								
1B	Regrouping IN Ponte de Sor		71,99	71,99	01:30 *	09:25		
1C	Regrouping OUT - Start Section 2					09:55		
<b>km 0,5 - Possible Refuelling (commercial filling stations indicated in the road book)</b>								
2	TC Start SS2		3,14	3,14	00:15	10:10		
<b>SS2 SS2 START</b>		<b>59,61</b>				<b>10:15</b>		
2A	SS2 Stop (Max Time 1h30m)			59,61		11:00		
<b>km 6,20 - Possible Refuelling (commercial filling stations indicated in the road book)</b>								
2B	Service Nerpor IN		28,35	28,35	01:00 *	12:00		
<b>SERVICE A (NERPOR)</b>		<b>63,32</b>	<b>110,51</b>	<b>173,83</b>	<b>03:00</b>			
2C	ARRIVAL Leg 1 / Parc Ferme Nerpor				03:00 *	15:00		
<b>Leg 1 totals</b>		<b>63,32</b>	<b>110,51</b>	<b>173,83</b>				

STAGE 2							Saturday, October 28	
Sunrise - 08:01							Sunset - 18:33	
TC	LOCATION	SS km	Liason km	Total km	Time	1st. Bike		
2D	START Section 3 / Leg 2 - NERPOR					08:40		
<b>km 32,13 - Possible Refuelling (refuelling provided by the team)</b>								
3	TC Start SS4		36,90	36,90	01:15	09:55		
<b>SS3 SS3 START</b>		<b>320,00</b>				<b>10:00</b>		
3A	SS4 STOP (Max Time 4h35m)			320,00		14:00		
<b>km 6,20 - Possible Refuelling (commercial filling stations indicated in the road book)</b>								
3B	ARRIVAL Leg 2 / Parc Fermé Nerpor		5,99	5,99	00:30 *	14:30		
<b>Leg 2 totals</b>		<b>320,00</b>	<b>42,89</b>	<b>362,89</b>				

RALLY TOTALS				
	SS	Liason	Total	% SS
Leg 1 - SS1 / SS2	63,32	110,51	173,83	36,4%
Leg 2 - SS3	320,00	42,89	362,89	88,2%
<b>Total</b>	<b>383,32</b>	<b>153,40</b>	<b>536,72</b>	<b>71,4%</b>

\* maximum time, check-in advance is authorized

V1 (30-05-23)

# APPENDIX V – GUIDELINES OF SECURITY AND LOCALISATION EQUIPMENT GPS/GSM

## MAIN SCREEN

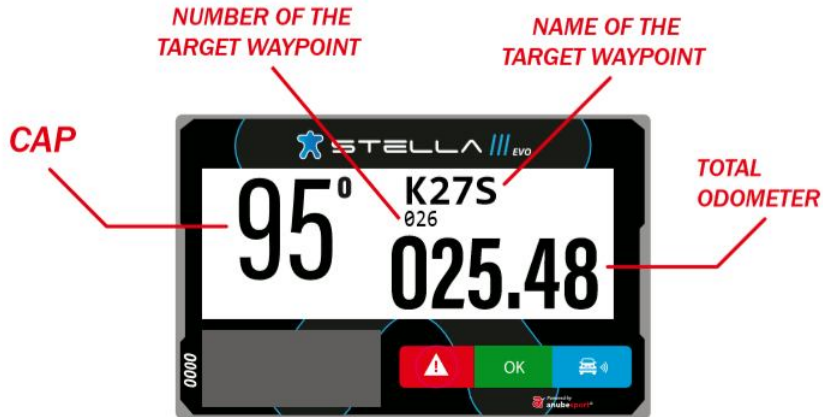

## SPEED ZONE

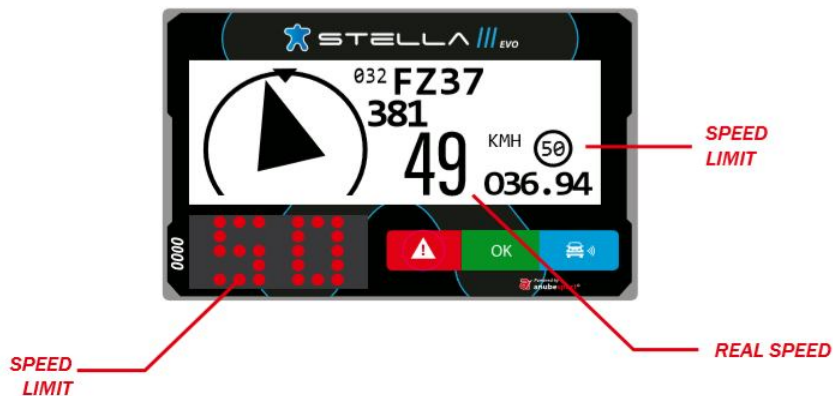

## WAYPOINT PROXIMITY



### REQUEST MEDICAL ATTENTION IMMEDIATELY



SOS



### CAUTION VEHICLE STATIONARY



3 sec. BREAKDOWN



### DANGER 3 !!!



Notification 300m before an area marked in the roadbook as "Danger 3"



## OVERTAKING / BLUE FLAG



FLASHING

OVERTAKE REQUEST



## OVERTAKING / BLUE FLAG



STEADY



FLASHING



## OVERTAKING / BLUE FLAG



FREE TO OVERTAKE



STEADY

PRESS THE BLUE BUTTON TO CONFIRM



### SPEED LIMIT



### SPEED LIMIT



YELLOW  
90m on approaching speed zone

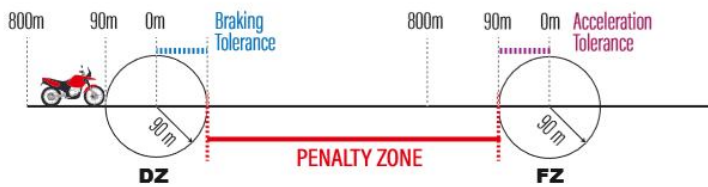

### SPEED LIMIT

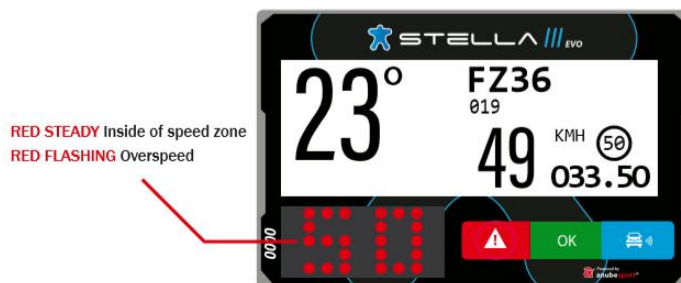

RED STEADY Inside of speed zone  
RED FLASHING Overspeed

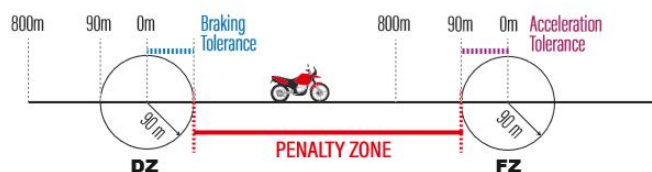

### SPEED LIMIT

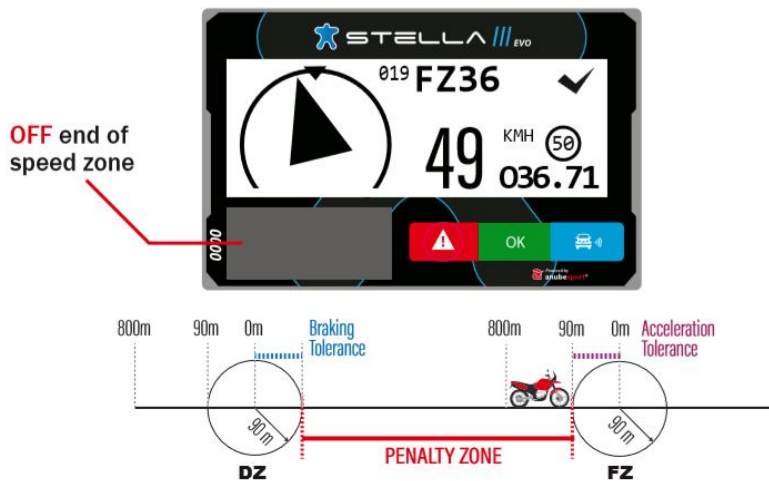

### NEUTRALIZATION ZONE

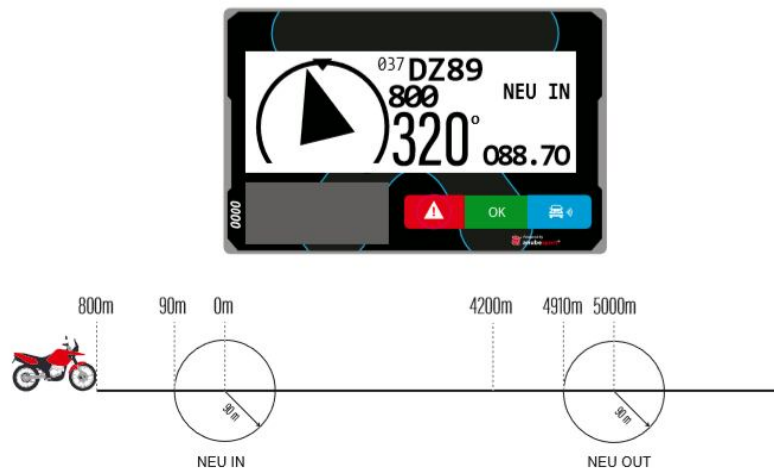

### NEUTRALIZATION ZONE



## WAYPOINTS LIST

OK

Powered by **anubespport**



## NEUTRALIZATION ZONE

Powered by **anubespport**

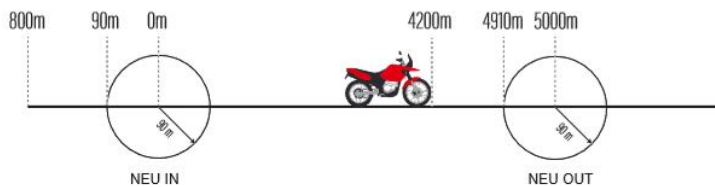

## NEUTRALIZATION ZONE

Powered by **anubespport**

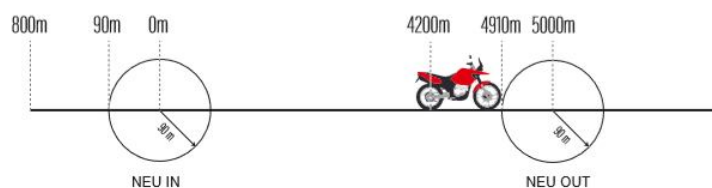

## WAYPOINT PROXIMITY



## TOTAL ODOMETER RESET TO ZERO



OK

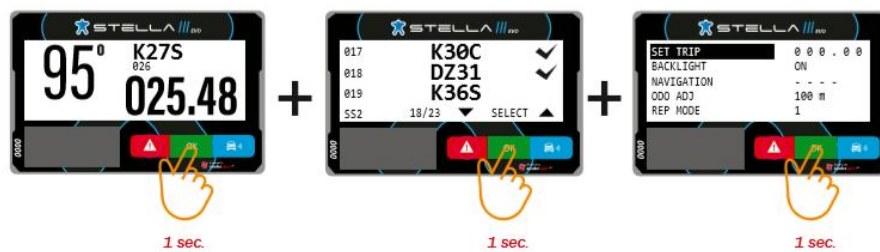

## Appendix 6 KIT for compulsory installation of STELLA III System



1 – Iridium Antenna / 2 – Power Cord / 3 – RF Cord / 4 – RF Antenna/ 5 – Base/Mount  
6 – GPS Antenna / 7 – Adhesive / 8 – Straps / 9 – User Manual

### IMPORTANT

For the functional test and verification, all vehicles must have through the installation of the mount, power cord, and antennas.

### 1. POWER CORD

- Connect the red wire to the positive end of battery 12V (+), and the grey wire to the negative (GRD). The power cord must be connected directly to the battery (without interruptions and without contact in the power supply).

- A 3A fuse (not included) should be connected to the red wire.

- Take the cord to the location in which the STELLA III EVO is to be installed. All other wires must be insulated, they cannot touch



## 2. BASE / MOUNT

ATV: The mount can be attached to the handle bar or to a metal plaque close to the navigation system.

- Car and SSV: The mount can be attached to the panel, or to the roll cage bars. STELLA III EVO buttons, must be visible and accessible to the participant (pilot/navigator) even when they are sitting and with the seatbelts buckled.

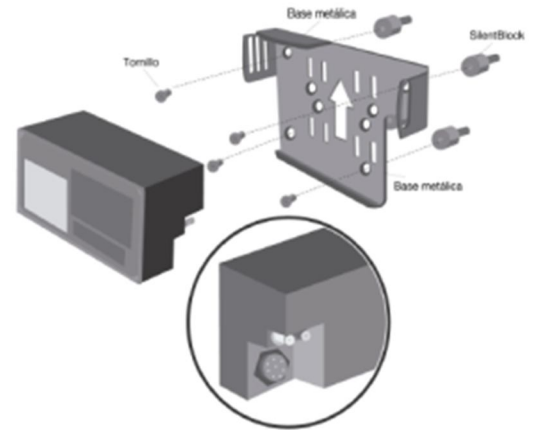

### IMPORTANT

Leave the cords (antenna and battery) in place with at least 10 cm to spare for easy handling. At least 5 cm of space behind the mount (bottom right corner) to allow space for power cord/connections.

## 3. GPS ANTENNA

- The GPS antenna must be installed horizontally and without obstructions toward the sky. In cars and SSV, it can be mounted on the roof, the hood, or the dashboard. In ATV, attach to the mudguard. For additional firmness, it is recommended to cover it with adhesive tape (non-metallic when mounting it to a metallic surface) and pull-up (when attached to soft or plastic parts).



## 4. IRIDIUM ANTENNA

The Iridium antenna must be installed horizontally and without obstructions toward the sky. In cars and SSV, it can be mounted on the roof, the hood, or the dashboard. In ATV, attach to the mudguard. For additional firmness, it is recommended to cover it with adhesive tape (no metallic when mounting it to a metallic surface) and pull-up (when attached to soft or plastic parts).



## THE USE OF THE TRACKING SYSTEM & ACCIDENT RESPONSE & CAR-TO-CAR COMMUNICATION SYSTEM 5. GPS ANTENNA

The radio-frequency antenna must be installed vertically to the roll cage bars (cars and SSV) and the (ATV). It is mandatory to use separators (included in kit) to avoid contact with metallic parts and the carbon that surrounds it.

Once the antennas are mounted, take the SMA connection cords to the base/mount where the STELLA III EVO will be installed.



forks  
the  
fibre





# GPS SPICA III



## SOS

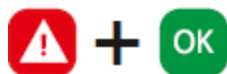

Press red and green buttons simultaneously for 2 seconds

REQUEST FOR IMMEDIATE MEDICAL ATTENTION

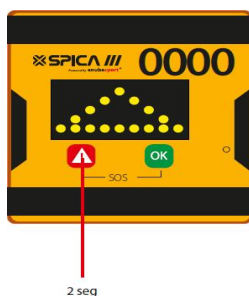

## CAUTION



Press Red button 2 seconds

VEHICLE STATIONARY



## OK?



Everything is OK

Clerck of course requests status to the participants



Pilots are NOT well. Next you have to issue an SOS



## DANGER !!!

Notification 300 m before an area marked in the roadook as "DANGER 3"

# SPEED

# LIMIT



**YELLOW** 90m on approaching speed zone



**RED STEADY** Inside the speed zone



**RED FLASHING** Overspeed



**OFF** end of speed zone

## NEUTRALIZATION ZONE



90m before a neutralized zone, appears **INE** on the screen



At the beginning of the zone, the remaining minutes will appear on the display in **red**. It will be updated each minute, but will only show on the screen for 5 seconds.



A **yellow** seconds countdown will appear in the last minute



**GO** will appear on the screen when the countdown ends. We can continue

## APPENDIX VI – SAFETY PLAN

### 1 – Location of the race control

**NERPOR-DE** Location: Nerpor (Portalegre)  
39°16.389'N / 7°25.271'W  
ASSOCIAÇÃO EMPRESARIAL  
DA REGIÃO DE PORTALEGRE

The race control will provide the hub for receiving data transmission from the selective sections that relates to any safety matters.

This centre will be equipped with three bearer systems for data concerning safety and sporting matters:

- Radio Communication equipment (multi-channel)
- Mobile telephones operating on GSM network
- GPS-GSM System

### 2 – Key personnel

- **Clerk of the Course Cars**  
Horácio Rodrigues – Tel. +351 917 582 729
- **Assistant Clerk of the Course Cars**  
Jaime Santos – Tel. +351 917 343 864  
Filipe Gaivão – Tel. +351 919 081 560  
Orlando Romana – Tel. +351 917 289 861
- **Clerk of the Course Bikes**  
Márcio Santos – Tel. +351 963 828 737
- **Assistant Clerk of the Course Bikes**  
Nelson Correia – Tel. +351  
Eduardo Rovisco – Tel. +351
- **Chief Medical Officer**  
Dr. Pedro Barradas – Tel. +351 964 065 446
- **Chief Security Officer**  
Jaime Santos – Tel. +351 917 343 864

### 3 – Safety officers in charge of safety for each selective section

- SS1 – Luis Marcão – Tel. +351 919 702 443
- SS2 – Filipe Viçoso – Tel. +351 962 743 385
- SS3 – Carlos Calhau – Tel. +351 963 173 720
- SS4 – Luis Marcão – Tel. +351 919 702 443

### 4 – Safety services in the area of each selective section

- Police (PSP) – Tel. +351 245 300 620
- National Guard (GNR) – Tel. +351 245 331 603
- Hospitals – José Maria Grande (Portalegre) – Tel. +351 245 301 000  
– Abrantes – Tel. +351 241 360 700
- Towage – ACP – Tel. +351 707 509 510

## 5 – Radio communication system

Four radio channels under Race Control supervision

- Channel 1 – Organization
- Channel 2 – Passage controls
- Channel 3 – Radio Points
- Channel 4 – Medical Team

## 6 – Medical equipment available

- 1 Medical Helicopter, with one Doctor
- 6 medical Teams, of one Doctor and one paramedic on 4Wheel Drive vehicles
- 10 ambulances
- 1 Medical Centre on Nerpor

## 7 – Location of the medical vehicles

- On the special stages, there will be one medical vehicle every 40 km's (minimum).
- One medical vehicle at the start and at the arrival of each special stage (or the Medical Assistance is given by the Medical Centre)

## 8 – Location of the passage control vehicles

In each special stage there will be:

- A car equipped with radio every 15 km (average)

Every intersection with an asphalt road will be monitored together with the police

## 9 – Safety of the crews

All competition vehicles will compulsorily be equipped with a tracking system.

## 10 – Rescue equipments

### Medical Vehicles

- 4 wheel drive vehicles
- with a Team of one Doctor and one Paramedic on board
- with a fuel capacity for 400 Km
- with a reserve of drinkable water for the Competitors
- with the possibility to transport an injured person lying down
- with 1 radio in permanent contact with the Race Control
- with 1 mobile phone

### Rescue Equipment of the Medical Vehicles

- 1 “reanimation box”;
- Intubations material;
- Urgent indictable;
- Diagnostic material;
- 1 survival mattress;

### **Medical Helicopter Equipment**

Similar equipment as the medical cars

- 1 portable suction machine;
- 1 respiratory fan;
- 1 Doctor qualified in reanimation

### **Medical Centre**

Similar equipment as the vehicles and Helicopter, and also:

Material:

- 1 tent
- supplementary medications and material
- 1 stretcher

### **Specialized Persons**

- 1 Chief Doctor
- 1 Doctor qualified in reanimation
- 1 Paramedic

## **11 – Closing of the route**

An Organization “sweeper” vehicle will close the route of the event, as notified in the road-book.

This vehicle will pick up the people whose vehicle is broken down or out of service, but in no case, broken-down vehicles will be towed.

Drivers who refuse to be transported by the sweeper vehicle do so under their own responsibility, and they must sign a discharge that will be handed to them by the route-closing members of the organization.

No claim based on the consequences of this refusal may be directed against the Organization. In case of retirement due to a mechanic failure on the special stage, the competitor must wait for the sweeper vehicle.

## **12 – Safety of the public**

In all spectators areas there will be a team of the Organisation, with radio, and the National Guard (GNR). Both on close contact with the Chief Safety Officer, for any reinforcement needed.

## **13 – Safety of the officials of the event**

Members of the Organisation, using mobile phones, will accompany all Officials.

**Some additional information will be given, to the Officials of the Event, on October 26<sup>th</sup>:**

- 1 – Programme
- 2 – Itinerary (map of controls)
- 3 – Rally officials phone numbers
- 4 – Emergency Phone numbers
- 5 – Safety Plan description
- 6 – Maps – Bivouac and HQ
- 7 – Maps – each SS and the Spectators areas
- 8 – Safety Plan synopsis
- 9 – Time average of competitor's in each SS
- 10 – Radio Network
- 11 – Official authorizations granted
- 12 – Hospitals and medical centres on duty



- 13 – Insurance of the event
- 14 – Environmental policy



**AUTOMÓVEL  
CLUB DE PORTUGAL**

Rua General Humberto Delgado, 3  
2685 - 340 PRIOR VELHO  
Tel: 351 219 429 187 Fax: 351 219 429 192  
acpmotorsport@acp.pt



## APPENDIX VII – SERVICE PARK LAYOUT

